

MANUFACTURED FROM FORGED PARTS

MATERIAL:

- Alloyed carburized steel at chrome-manganese 1.7131 (16MnCr5).

EXECUTION:

- Carburized, hardness.
- Surface hardness HRC 58 ± 2 (670 ± 40 HV30)
- Depth minimum 0,5 mm.
- Tensile strength in core minimum 800 N/mm² after carburizing.

ACCURACY:

- Taper according to DIN 254
- Taper angle: tolerance AT 3 DIN 7178 part 1 and DIN 2080 part 1.
- Other tolerances according to DIN 7160 and 7168.
- Taper surface roughness $R_z < 0,001$ mm.

HERGESTELLT AUS GESCHMIEDETEN TEILEN

MATERIAL:

- Legierter Aufgekohlter Stahl mit Chrom-Mangan 1.7131 (16MnCr5).

KONSTRUKTIONS DATEN:

- Aufgekohlt, gehärtet und angelassen.
- Oberflächenhärte HRC 58 ± 2 (670 ± 40 HV30).
- Aufgekohlt auf minimum 0,5 mm Tiefe.
- Zugfestigkeit im Kern minimum 800 N/mm² nach der Aufkohlung.

GENAUIGKEIT:

- Dorn nach DIN 254.
- Kegelwinkel: Toleranz AT 3 DIN 7178 Teil 1 und DIN 2080 Teil 1.
- Andere Toleranzen entsprechend DIN 7160 und 7168.
- Rauigkeit der Oberfläche $R_z < 0,001$ mm.

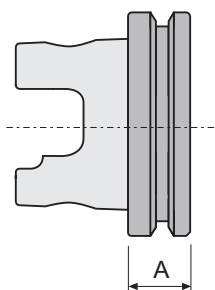

TOLERANCE AT:

- Indicates the tolerance of size D surface between the real and the theoretical value of the taper conicity.
- This value of surface D must always be less (negative), never more (positive) in order to GUARANTEE a good toolholder fixation at the bigger taper diameter.

TOLERANZ AT:

- Zeigt die Toleranz auf der Messebene D zwischen dem tatsächlichen Wert der Kegelkonizität und dem theoretischen Wert.
- Dieser Wert auf der Messebene D sollte immer minus (negativ) sein, nie plus (positiv), um für einen guten Halt des Futters in den größeren Durchmesser des Kegels zu garantieren.

17

ISO 26622-1

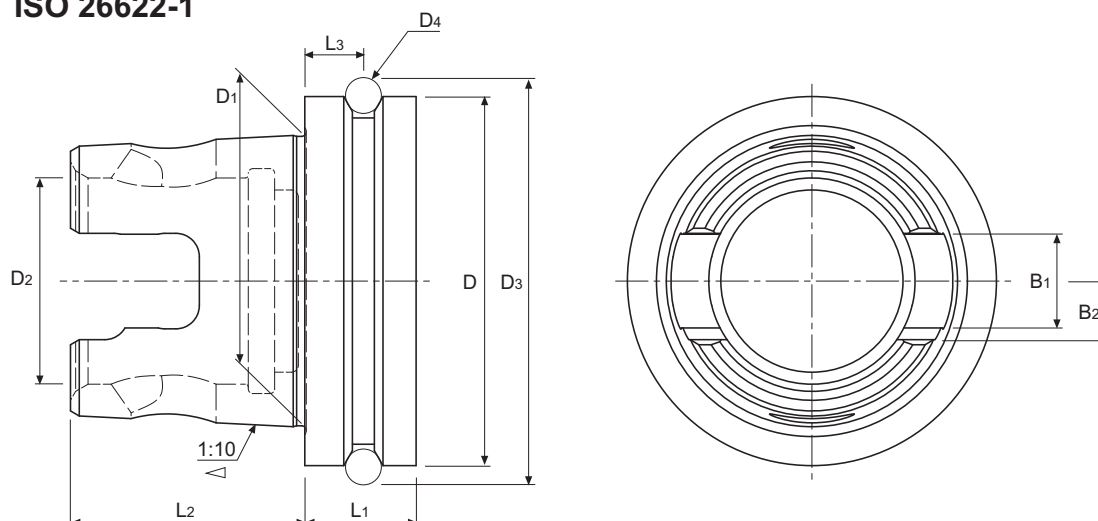

TS	D mm	D ₁ mm	D ₂ mm	D ₃ mm	D ₄ mm	L ₁ min mm	L ₂ mm	L ₃ mm	B ₁ mm
40	40	30	21,0	44,45	3,5	12	25	6	10
50	50	40	28,2	59,40	7,0	18	32	9	14
63	63	50	35,2	72,40	7,0	20	40	10	16
80	80	64	48,0	89,40	7,0	22	45	11	20
100	100	82	62,0	109,40	7,0	22	50	11	24

<p>17.160</p>  <p>D.02</p>	<p>17.215</p>  <p>D.03</p>	<p>17.296</p>  <p>D.04</p>	<p>17.306</p>  <p>D.05</p>	<p>17.315</p>  <p>D.06</p>
<p>17.453</p>  <p>D.07</p>	<p>17.470</p>  <p>D.08</p>	<p>17.500</p>  <p>D.09</p>	<p>17.510</p>  <p>D.10</p>	<p>17.520</p>  <p>D.11</p>
<p>17.530</p>  <p>D.12</p>	<p>17.540</p>  <p>D.13</p>	<p>17.550</p>  <p>D.14</p>	<p>17.620</p>  <p>D.15</p>	<p>17.999</p>  <p>D.16</p>

17
TS ISO 26622-1

18
PSC ISO 26623-1

20 23
JIS B 6339-BT

25
CHIRON

BORING HEADS
BOHRKÖPFE



MORSE SHANKS
MORSE SCHÄFTE

CYLINDRICAL SHANKS
ZYLINDRISCHE SCHÄFTE

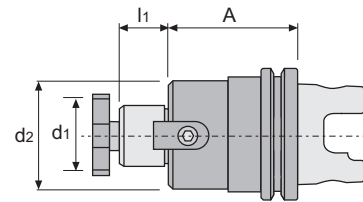
ACCESSORIES
ZUBEHÖR



REF.	TS	d ₁ h6 mm	A mm	l ₁ mm	d ₂ mm	kg
17.160.040.16	40	16	55	17	37	-
17.160.040.22		22	55	19	47	-
17.160.050.16	50	16	63	17	37	-
17.160.050.22		22	63	19	47	-
17.160.050.27		27	63	21	58	-
17.160.050.32		32	63	24	63	-
17.160.063.16	63	16	63	17	37	-
17.160.063.22		22	28	19	47	-
17.160.063.22/63		22	63	19	47	-
17.160.063.27		27	28	21	58	-
17.160.063.27/63		27	63	21	58	-
17.160.063.32		32	28	24	78	-
17.160.063.32/63		32	63	24	78	-
17.160.063.40		40	86	27	88	-

REF.			
17.160.040.16	10008	86016	11103
17.160.040.22	10010	86022	11004
17.160.050.16	10008	86016	11103
17.160.050.22	10010	86022	11004
17.160.050.27	10012	86027	11005
17.160.050.32	10016	86032	11105
17.160.063.16	10008	86016	11103
17.160.063.22	10010	86022	11004
17.160.063.22/63	10010	86022	11004
17.160.063.27	10012	86027	11005
17.160.063.27/63	10012	86027	11005
17.160.063.32	10016	86032	11105
17.160.063.32/63	10016	86032	11105
17.160.063.40	10020	86040	11006

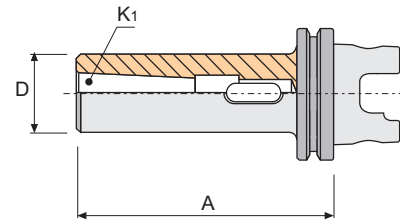

REF.	TS	K ₁ MORSE	A mm	D mm	
17.215.050.02	50	2	110	32	-
17.215.050.03		3	130	40	-
17.215.063.02	63	2	110	32	-
17.215.063.03		3	130	40	-
17.215.063.04		4	150	52	-

10
DIN 208011 13
DIN 69871-A16
HSK DIN 69893-117
TS ISO 26622-1

CNC-UNIVERSAL PRECISION DRILL CHUCKS

for left and right hand turn

UNIVERSALER CNC-BOHRFUTTER, GENAUIGKEITSAUSFÜHRUNG

für links- und rechtslaufende Bearbeitungen

TS ISO 26622-1

17.296

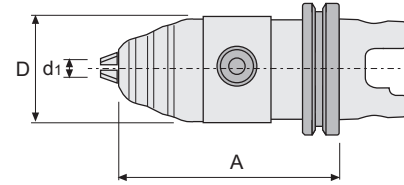



REF.	TS	D mm	d ₁ mm	A mm	
17.296.040.13	40	50	0.5 - 13	112	-
17.296.050.13	50	50	0.5 - 13	112	-
17.296.063.13	63	50	0.5 - 13	112	-
17.296.063.16		57	3.0 - 16	112	-

* SUPPLIED WITH WRENCH / * GELIEFERT MIT SCHLÜSSEL

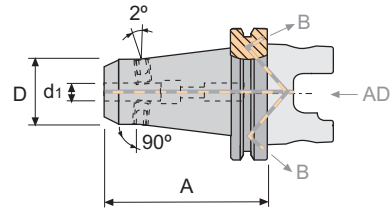
REF.		3 x
17.296.040.13	50706	60313
17.296.050.13	50706	60313
17.296.063.13	50706	60313
17.296.063.16	50706	60313



REF.	TS	d ₁ mm	D mm	A mm	2 x 	
17.306.040.06	40	06	25	50	15006	-
17.306.040.08		08	28	50	15008	-
17.306.040.10		10	35	50	15010	-
17.306.040.12		12	42	55	15012	-
17.306.040.16		16	48	55	15114	-
17.306.050.06	50	06	25	55	15006	-
17.306.050.08		08	28	55	15008	-
17.306.050.10		10	35	65	15010	-
17.306.050.12		12	42	65	15012	-
17.306.050.14		14	42	65	15012	-
17.306.050.16		16	48	65	15114	-
17.306.050.18		18	48	65	15114	-
17.306.050.20		20	52	65	15116	-
17.306.050.25		25	65	80	4 x 15018	-
17.306.063.06	63	06	25	80	15006	-
17.306.063.08		08	28	80	15008	-
17.306.063.10		10	35	80	15010	-
17.306.063.12		12	42	80	15012	-
17.306.063.14		14	42	80	15012	-
17.306.063.16		16	48	80	15114	-
17.306.063.18		18	48	80	15114	-
17.306.063.20		20	52	80	15116	-
17.306.063.25		25	65	90	4 x 15018	-
17.306.063.32		32	72	90	4 x 15120	-
17.306.063.40		40	80	95	4 x 15120	-

17
TS ISO 26622-1

18
PSC ISO 26622-1

20 23
JIS B 6339-BT

25
CHIRON

BORING HEADS
BOHRKÖPFE

MORSE SHANKS
MORSE SCHÄFTE

CYLINDRICAL SHANKS
ZYLINDRISCHE SCHÄFTE

ACCESSORIES
ZUBEHÖR

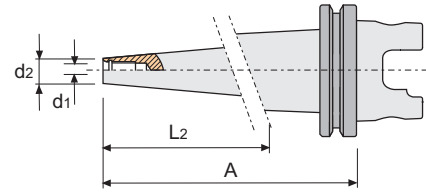

REF.	TS	A mm	d ₁ mm	d ₂ mm	L ₂ mm	kg
17.315.040.08	40	70	M8	13	41,8	-
17.315.040.10		80	M10	18	52,4	-
17.315.040.12		80	M12	21	52,8	-
17.315.050.08	50	70	M8	13	40,4	-
17.315.050.10		80	M10	18	51,1	-
17.315.050.12		80	M12	21	51,5	-
17.315.050.16		80	M16	29	52,6	-
17.315.063.08	63	70	M8	13	35,1	-
17.315.063.10		90	M10	18	55,8	-
17.315.063.12		100	M12	21	66,2	-
17.315.063.16		100	M16	29	67,3	-

REF.	ACCESSORIES / ZUBEHÖR
06.315	Front contact extensions for modular tools. / Stirnverlängerung für Einschraubfräser.
06.315	Front contact reducers for modular tools. / Stirnreduzierhülsen für Einschraubfräser.







06.315

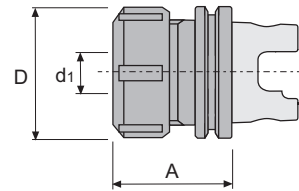

06.315

For more information see page / Für weitere Informationen siehe Seite: J.02, J.03



REF.	TS		A mm	d ₁ mm	D mm			
17.453.040.16	40	ER16	60	0,5-10	28	45316	50216	-
17.453.040.20		ER20	60	1-13	34	45320	50220	-
17.453.040.25		ER25	60	1-16	42	45325	50225	-
17.453.040.32		ER32	60	2-20	50	45332	50232	-
17.453.050.16	50	ER16	60	0,5-10	28	45316	50216	-
17.453.050.16/100		ER16	100	0,5-10	28	45316	50216	-
17.453.050.20		ER20	60	1-13	34	45320	50220	-
17.453.050.20/100		ER20	100	1-13	34	45320	50220	-
17.453.050.25		ER25	60	1-16	42	45325	50225	-
17.453.050.25/100		ER25	100	1-16	42	45325	50225	-
17.453.050.32		ER32	60	2-20	50	45332	50232	-
17.453.050.32/100		ER32	100	2-20	50	45332	50232	-
17.453.050.40		ER40	65	3-30	63	45340	50240	-
17.453.050.40/100		ER40	100	3-30	63	45340	50240	-
17.453.063.16	63	ER16	60	0,5-10	28	45316	50216	-
17.453.063.16/100		ER16	100	0,5-10	28	45316	50216	-
17.453.063.20		ER20	60	1-13	34	45320	50220	-
17.453.063.20/100		ER20	100	1-13	34	45320	50220	-
17.453.063.25		ER25	60	1-16	42	45325	50225	-
17.453.063.25/100		ER25	100	1-16	42	45325	50225	-
17.453.063.32		ER32	60	2-20	50	45332	50232	-
17.453.063.32/100		ER32	100	2-20	50	45332	50232	-
17.453.063.40		ER40	65	3-30	63	45340	50240	-
17.453.063.40/100		ER40	100	3-30	63	45340	50240	-

* If you want with ball bearing nut, see page: K.22
 * Wenn Sie diese mit Kugellager-Nute möchten, siehe Seite: K.22

* SUPPLIED WITHOUT WRENCH / * GELIEFERT OHNE SCHLÜSSEL

REF.	ACCESSORIES / ZUBEHÖR
ERXX	Collets double slot DIN 6499 - Form B (ER) / Spannanzgen mit Doppelnut DIN 6499 - Form B (ER)
ERCXX	Sealed collets DIN 6499 (ER) / Abgedichtete Spannanzgen DIN 6499 (ER)
ERTXX	Collets DIN 6499 - Form Mexin (ER) / Spannanzgen DIN 6499 - Form Mexin (ER)
40.453..	Collet chucks for DIN 6499 (ER) collets / Spannanzgenfutter für DIN 6499 (ER) Spannanzgen
40.455..	Long collet chucks for DIN 6499 (ER) collets / Lange Spannanzgenfutter für DIN 6499 (ER) Spannanzgen



ERXX



ERCXX



ERTXX



40.453..



40.455..

For more information see page / Für weitere Informationen siehe Seite: K.13, K.17, K.19, J.08, J.09

10
DIN 208011 13
DIN 69871-A16
HSK DIN 69893-117
TS ISO 26622-1

BLANK ADAPTORS

ROHLINGE MIT WEICHEM SCHAFT

TS ISO 26622-1

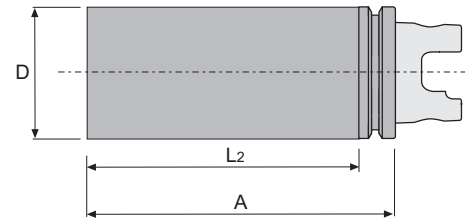

17.470

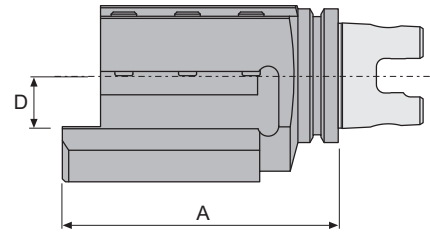

REF.	TS	D mm	L2 mm	A mm	Kg
17.470.050.50/200	50	50	182	200	-
17.470.050.63/200		63	182	200	-
17.470.063.63/200	63	63	180	200	-
17.470.063.80/250		80	230	250	-
17.470.063.109/134		109	114	134	-
17.470.100.63/200	100	63	178	200	-
17.470.100.80/250		80	228	250	-
17.470.100.90/300		90	278	300	-



REF.	TS	D mm	A mm	
17.500.063.25 R/L	63	25	130	-
<p>Turning toolholder for square tool left/right hand. Drehen Werkzeughalter für Vierkantmeißel links / rechts.</p>				

REF.		
17.500.063.25 R/L	17012	29710

17
TS ISO 26622-1

18
PSC ISO 26623-1

20 23
JIS R 6339-RT

25
CHIRON

BORING HEADS
BOHRKÖPFE

MORSE SHANKS
MORSE SCHÄFTE

CYLINDRICAL SHANKS
ZYLINDRISCHE SCHÄFTE

ACCESSORIES
ZUBEHÖR

10
DIN 2080

AXIAL HOLDER



AXIAL WERKZEUGHALTER

TS ISO 26622-1

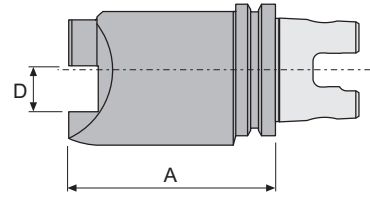
17.510



11 13
DIN 69871-A16
HSK DIN 69893-117
TS ISO 26622-1

REF.	TS	D mm	A mm	
17.510.063.25 R/L	63	25	130	-
Turning toolholder for square tool left/right hand. Drehen Werkzeughalter für Vierkantmeißel links / rechts.				

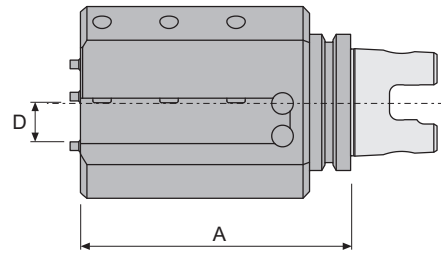
REF.		
17.510.063.25 R/L	17012	29710



REF.	TS	D mm	A mm	
17.520.063.25 R/L	63	25	130	-
<p>Multipurpose square toolholder. Multipurpose Platz Werkzeughalter.</p>				

REF.		
17.520.063.25 R/L	17012	29710

- 17 TS ISO 26622-1
- 18 PSC ISO 26623-1
- 20 23 JIS R 6339-RT
- 25 CHIRON
- BORING HEADS
BOHRKÖPFE
- MORSE SHANKS
MORSE SCHÄFTE
- CYLINDRICAL SHANKS
ZYLINDRISCHE SCHÄFTE
- ACCESSORIES
ZUBEHÖR

10
DIN 208011 13
DIN 69871-A16
HSK DIN 69893-117
TS ISO 26622-1

AXIAL HOLDER



AXIAL WERKZEUGHALTER

TS ISO 26622-1

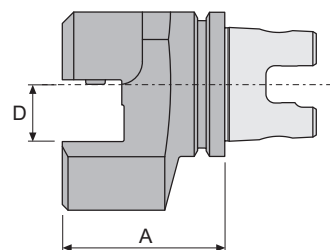
17.530



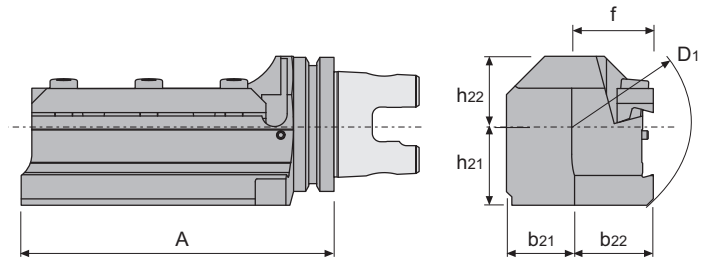

REF.	TS	D mm	A mm	
17.530.063.25	63	25	60	-
Multipurpose square toolholder. Multipurpose Platz Werkzeughalter.				

REF.		
17.530.063.25	17012	29710



REF.	TS	D ₁ mm	b ₂₁ mm	b ₂₂ mm	f mm	h ₂₁ mm	h ₂₂ mm	A mm	
17.540.063.32	63	106	32	37	32	38	32	147	3,300

REF.		
17.540.063.32	80632	11306

17
TS ISO 26622-1

18
PSC ISO 26623-1

20 23
JIS B 6339-RT

25
CHIRON

BORING HEADS
BOHRKÖPFE

MORSE SHANKS
MORSE SCHÄFTE

CYLINDRICAL SHANKS
ZYLINDRISCHE SCHÄFTE

ACCESSORIES
ZUBEHÖR

10
DIN 2080

11 13
DIN 69871-A

16
HSK DIN 69893-1

17
TS ISO 26622-1



AXIAL HOLDER
AXIAL WERKZEUGHALTER

TS ISO 26622-1



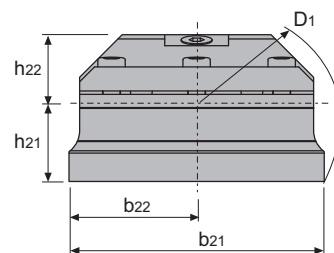
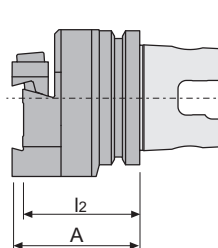

17.550

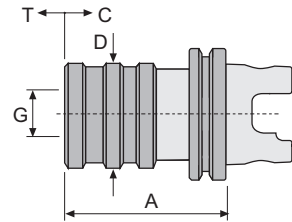

REF.	TS	D ₁ mm	b ₂₁ mm	b ₂₂ mm	h ₂₁ mm	h ₂₂ mm	A mm	l ₂₂ mm	Kg
17.550.063.32	63	141	120	60	37	32	60	55	2,300

REF.		
17.550.063.32	80632	11306



REF.	TS	G N ^o . Ø		A mm	D mm	C mm	T mm			
17.620.040.12	40	1 19	M3-M12	65	38	9	9	710XX	750XX	-
17.620.050.12	50	1 19	M3-M12	65	38	9	9	710XX	750XX	-
17.620.063.12	63	1 19	M3-M12	70	38	9	9	710XX	750XX	-
17.620.063.20		2 31	M8-M20	95	55	15	15	720XX	760XX	-
17.620.063.33		3 48	M14-M33	140	79	24	24	730XX	770XX	-

COMPENSATION IN COMPRESSION (C) AND TENSION (T)
 AUSGLEICH DER KOMPRESSION (C) UND DER TRAKTION (T)

REF.	ACCESSORIES / ZUBEHÖR
710XX..730XX	Quick change adapters without overload clutch / Schnellwechseleinsätze ohne Sicherheitskupplung
750XX..770XX	Quick change adapters with overload clutch / Schnellwechseleinsätze mit Sicherheitskupplung



710XX..730XX



750XX..770XX

For more information see page / Für weitere Informationen siehe Seite: K.06, K.07

10
DIN 208011 13
DIN 69871-A16
HSK DIN 69893-117
TS ISO 26622-1

CONTROL PINS

PRÜFDORNE

TS ISO 26622-1

17.999

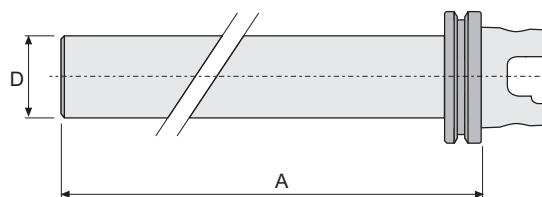

REF.	TS	A	D	
17.999.040	40	300	40	-
17.999.050	50	300	40	-
17.999.063	63	300	40	-
17.999.080	80	300	50	-
17.999.100	100	300	50	-

1 TYPE / TYP

17.160 	17.215 	17.296 	17.306 	17.315
17.453 	17.470 	17.500 	17.510 	17.520
17.530 	17.540 	17.550 	17.620 	

2 DIMENSION / ABMESSUNG

40	50	63	80	100
-----------	-----------	-----------	-----------	------------

3 LENGTH (A) / LÄNGE (A)

<p>A</p>	<hr/> <hr/> <hr/> <hr/> <hr/>
----------	-------------------------------

DIAMETER / DURCHMESSER	MK	ISO	COLLET SPANNZANGE
<p>D</p>	<p>MK</p>	<p>ISO</p>	

NOTES: _____

17
TS ISO 26622-1

18
PSC ISO 26623-1

20 23
JIS B 6339-BT

25
CHIRON

BORING HEADS
BOHRKÖPFE

MORSE SHANKS
MORSE SCHÄFTE

CYLINDRICAL SHANKS
ZYLINDRISCHE SCHÄFTE

ACCESSORIES
ZUBEHÖR